

K-2189T-1/-4/-8 珀特勒 PARTRAIT®

釉面陶瓷围口修边式台上脸盆 VITREOUS CHINA SELF-RIMMING LAVATORY 切割图/安装说明书 CUT-OUT TEMPLATE / INSTALLATION INSTRUCTION

沿此线切割
CUT ALONG THIS LINE

脸盆边缘
RIM OF LAVATORY

安装之前

- 留意当地所有给排水及建筑规定。
- 检查污水管及供水管，如有需要请更换。
- 安装之前，先开启新脸盆的包装，并小心检查脸盆是否有损坏，再将脸盆放回包装盒内，到安装时才取出。
- 若为更换新脸盆，须确保现有的柜台孔口与新脸盆的切割位相同或较后者小。
- 请使用同时印在此说明书上的切割图，标划正确之切割位。
- 如果脸盆已随附密封胶，请勿使用其它密封胶。
- 科勒洗脸盆是根据美国标准制造的，与美式洗脸盆配件相配。其它洗脸盆配件可能与之不相配。

所需工具及物料 (不随货供应)

- 模板(已提供)
- 密封胶(视型号提供)
- 护眼镜
- 炭笔
- 剪刀
- 卷尺
- 涂油灰刀
- 水管用油灰
- 钢锯
- 匙孔线锯或手提电锯
- 锯(直径为13mm钻头或更大)
- 活动扳钳
- 喉管扳钳
- 切管刀

尺寸图

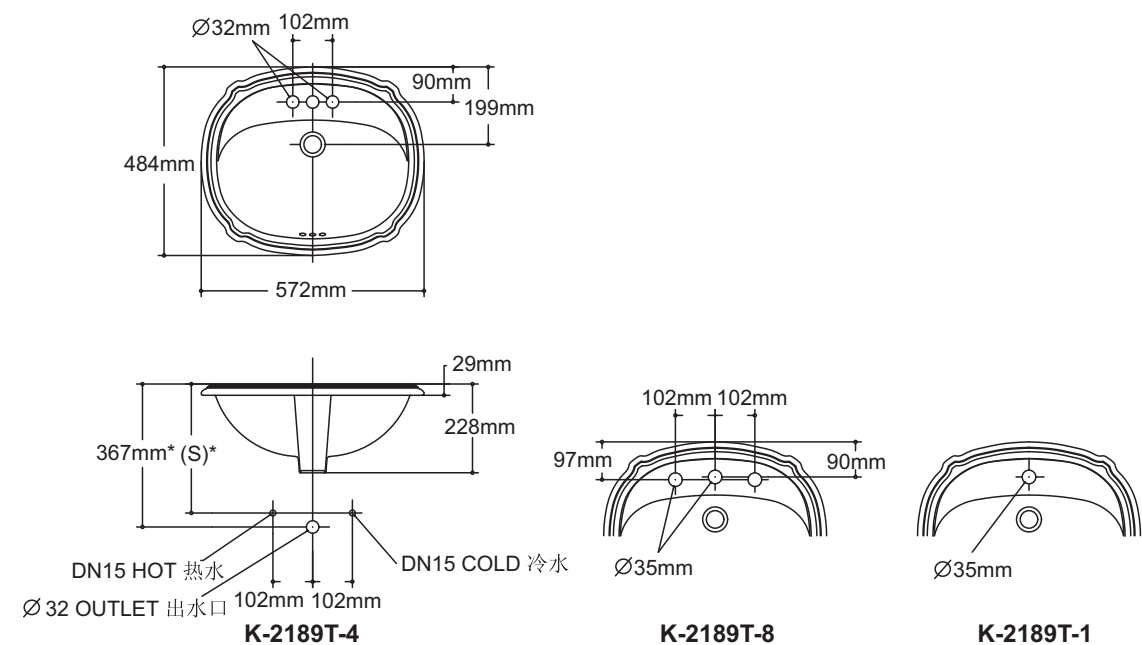

BEFORE YOU BEGIN

- Observe all local plumbing and building codes.
- Inspect the waste and supply tubing; replace if necessary.
- Prior to installation, unpack the new lavatory and carefully inspect it for damage. Return the lavatory to its protective carton until you are ready to install it.
- For replacement installations, make sure the existing cutout is the same or smaller size as the new lavatory.
- Use the template supplied with the lavatory to mark correct size cutout.
- Do not substitute another sealant if one is supplied with this lavatory.
- Kohler lavatory is made according to American National Standard that it can match the American lavatory fittings. Any other lavatory fittings may not fit for Kohler lavatory.

TOOLS AND MATERIALS (Not Supplied)

- Template(supplied)
- Sealant (may be supplied with some models)
- Safety Glasses
- Pencil
- Scissors
- Tape Measure
- Putty Knife
- Plumbers putty
- Hacksaw
- Keyhole Saw or Saber Saw
- Drill (13mm or 1/2" dia. drill bit or larger)
- Adjustable Wrench
- Pipe wrench
- Tubing Cutter

ROUGH-IN

拆除旧脸盆

- 关掉水龙头的供水源。
- 打开龙头阀门，然后断开供水管。
- 再旋开排水装置，并拿开弯管。
- 移走旧脸盆。

安装新脸盆

- 将切割图沿切割线切出。
- 将切割图放在盥洗台上，确保脸盆、水龙头和防溅挡板之间有足够距离。
- 检查盥洗台下的储物柜也有足够空间。

- 用炭笔沿切割图在盥洗台面划线。
- 再次检查脸盆、水龙头、防溅水板及储物柜的空间及距离。如有需要可调整切割图的位置。

- 用一个13mm的钻头，在切割图内侧钻一个导孔。
- 沿着自切割图勾划出来的铅笔线内侧切开台面。

- 暂将脸盆放入台面开口，校正位置。

小心：提防身体受伤或损坏产品。 因大型脸盆相当重，需找人帮您一起搬动及安放。

- 用炭笔沿脸盆外缘在盥洗台上划线。
- 然后将脸盆移开。
- 按照制造商的指引，安装水龙头和排水管道。

- 沿炭笔导线内侧涂两滴密封胶。

注意： 如果脸盆已随附密封胶，请勿使用其它密封胶。

- 用涂油灰刀将其抹匀。

小心：提防身体受伤或损坏产品。 因大型脸盆相当重，需找人帮您一起搬动及安放。

- 立即擦去多余的密封胶，如脸盆外缘与台面间有缝隙，即用胶填满。
- 检查脸盆的位置准确。
- 最少待三十分钟，让密封胶干透后，方可继续进行安装。
- 联接水龙头供水管。
- 联接排水装置。
- 开启水龙头阀门，检查有否渗漏。
- 用非腐蚀性清洁剂来清洁。

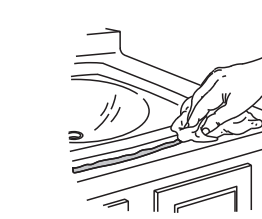
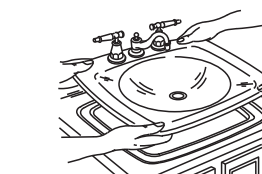
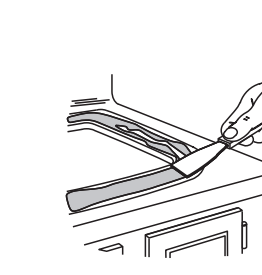
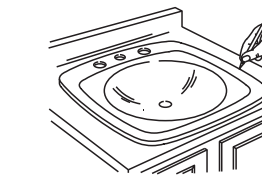
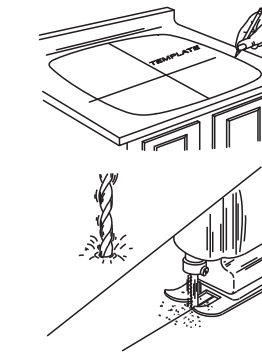
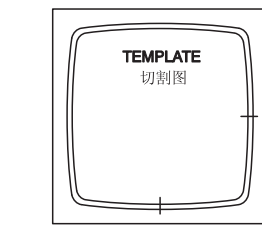
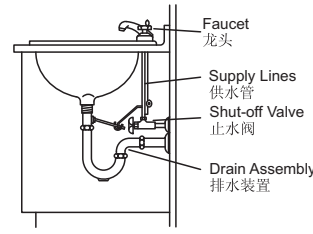

REMOVE EXISTING LAVATORY

- Turn off the water supply to the faucet.
- Open the faucet valves, then disconnect the supply lines.
- Disconnect the drain assembly and remove the trap.
- Remove the existing lavatory.

INSTALL NEW LAVATORY

- Cut the template on the cutout line.
- Position the template on the countertop to ensure clearance between the lavatory, faucet, and backsplash.
- Verify cabinet clearance beneath the countertop.

- Trace the template on the countertop with a pencil.
- Re-check the clearance between the lavatory, faucet, backsplash, and cabinet. Adjust the template accordingly.

- Drill a 13mm hole on the inside of the cutout opening.
- Cut the opening in the countertop along the inside edge of the pencil line.

- Temporarily position the lavatory in the opening, and adjust to fit.

CAUTION: Risk of personal injury or product damage. Large lavatories are very heavy. Get help lifting the lavatory into place.

- Trace a pencil line around the outside edge of the lavatory.
- Remove the lavatory.
- Install the faucet and drain according to the manufacturers instructions.

- Apply two beads of sealant to the inside of the pencil line.

NOTE: Do not substitute another sealant if one is supplied with this lavatory.

- Spread the sealant evenly with a putty knife.

- Carefully position the lavatory in the cutout, and press down firmly.

CAUTION: Risk of personal injury or product damage. Large lavatories are very heavy. Get help lifting the lavatory into place.

- Immediately wipe away any excess sealant, and fill any voids as needed.
- Verify that the lavatory has not moved out of position.
- Allow the sealant to cure for at least 30 minutes before proceeding.
- Connect the faucet supply lines.
- Connect the drain assembly.
- Open the faucet valves, and check for leakage.
- Clean up with a non-abrasive cleaner.

用户须知 (护理和清洁)

为保持脸盆光洁如新，须确保每次使用后彻底冲洗干净。切勿使用腐蚀性的清洁剂，以免刮花及破坏脸盆的表面。要清除顽固污垢、油漆或柏油，可使用松油或油漆稀释剂。

陶瓷及浴缸产品及配件担保 —— 一年有限担保

科勒公司担保其陶瓷及浴缸产品及配件在制造工艺上无瑕疵。

本产品自购买之日起即获得本公司一年的质量保证。在质保期内，凭购货发票，科勒公司将免费承担由制造质量问题引起的任何问题。经核查后，科勒中国有限公司有权决定是修理、更换，还是作适当的调整。

这里所指的担保，包括产品，都已明确地限制在该担保期之内。科勒中国有限公司对其后出现的损坏不负有任何责任。担保也不包括外观损伤。使用不当以及未按说明书安装的损失。

为获得快捷的担保服务，请联系您的经销商；您也可写信给科勒中国有限公司(请出示销售发票原件作为购货凭证)：

科勒(中国)投资有限公司
中央客户服务中心
上海市卢湾区淮海中路138号
上海广场19楼
邮编：200021

这是我们全部的书面担保。

IMPORTANT CONSUMER INFORMATION (CARE AND CLEANING)

To keep your lavatory looking new, make sure you rinse it out thoroughly after each use. **DO NOT USE ABRASIVES** on this product, as they will scratch and ruin the surface. Stubborn stains, paint, or tar can be removed with turpentine or paint thinner.

Plumbing Fixtures and Fittings Limited One-year Warranty

Kohler plumbing fixtures and fittings are warranted to be free of manufacturing defects.

This product is warranted for one year from date of purchase. Kohler China will be responsible for any problems caused by manufacturing defects provided with the invoice. Kohler China will, at its election, repair, replace or make appropriate adjustment where Kohler China inspection discloses any such defects occurring in normal usage within one year after purchase.

Implied warranties including that of merchantability and fitness for a particular purpose are expressly limited in duration to the duration of this warranty. Kohler China disclaims any liability for special, incidental or consequential damages. Damages to the product caused by misuse, abuse and installation that is not in accordance with the owner's manual are not covered by this warranty.

To obtain quick warranty service, please contact your dealer, or write to Kohler China. (Original sales receipt must be provided as the proof of purchase.)

Kohler China Investment Company Ltd.
Central Customer Service Center
19/F, Shanghai Square, 138 Huai Hai Road, Luwan District, Shanghai, PRC
Zip Code: 200021

This is our exclusive written warranty.

1038241-T01-A

© 版权为科勒中国有限公司所有, 2007
© Copyright Kohler China Ltd., 2007