

K-20338T-1/8 DELTA 德塔

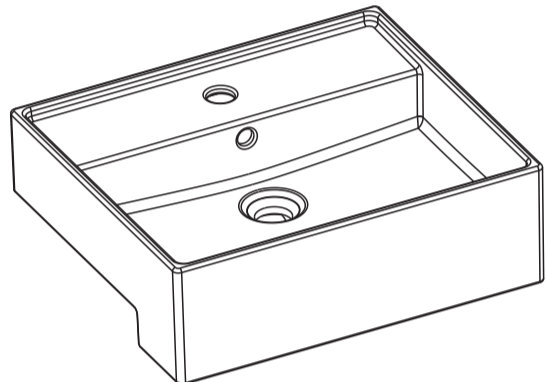

SEMI RECESSED VESSEL LAVATORY 方形半嵌入式脸盆 CUT-OUT TEMPLATE / INSTALLATION INSTRUCTIONS 切割图/安装说明书



BEFORE YOU BEGIN

- Observe all local plumbing and building codes.
- Inspect the waste and supply tubing; replace if necessary.
- Prior to installation, unpack the new lavatory and carefully inspect it for damage. Return the lavatory to its protective carton until you are ready to install it.
- For replacement installations, make sure the existing cutout is the same or smaller size as the new lavatory.
- Use the template supplied with the lavatory to mark correct size cutout.
- Kohler lavatory is made according to American National Standard that it can match the American lavatory fittings. Any other lavatory fittings may not fit for Kohler lavatory.
- Fixture dimensions are nominal and conform to tolerances established by ASME Standards (A112.19.2-2018).
- The product complies with GB 6952-2015.

安装之前

- 留意当地所有给排水及建筑规定。
- 检查污水管及供水管，如有需要请更换。
- 安装之前，先开启新脸盆的包装，并小心检查新的脸盆是否有损坏，再将脸盆放回包装盒内，到安装时才取出。
- 若为更换新脸盆，须确保现有的柜台孔口与新脸盆的切割位相同或较后者小。
- 请使用同时印在此说明书上的切割图，标记正确之切割位。
- 科勒洗脸盆是根据美国标准制造的，与美式洗脸盆配件相配，其它洗脸盆配件可能与之不匹配。
- 部件尺寸为标定值，误差符合美国ASME标准(A112.19.2-2018)。
- 本产品符合GB 6952-2015。

TOOLS AND MATERIALS (Not Supplied)

- Template (supplied)
- Safety glasses
- Pencil
- Scissors
- Tape measure
- Putty knife
- Plumbers putty
- Hacksaw
- Keyhole saw or saber saw
- Drill (10mm drill bit)
- Adjustable wrench
- Pipe wrench
- Tubing cutter

所需工具及物料 (不随货供应)

- 模板(已提供)
- 护眼镜
- 铅笔
- 剪刀
- 卷尺
- 涂油灰刀
- 水管用油灰
- 钢锯
- 匙孔线锯或手锯
- 钻(直径为10mm钻头)
- 活动扳钳
- 喉管扳钳
- 切管刀

ROUGHING-IN

Reference Value 参考值

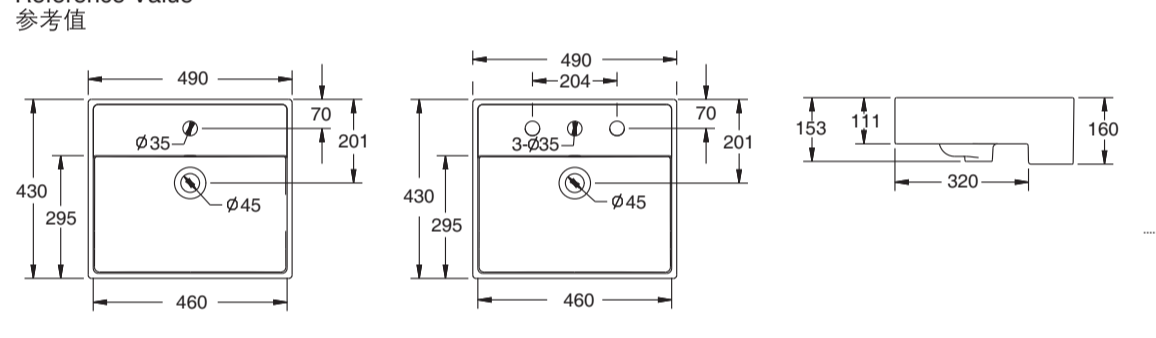

| Total Length 总长 | Inner Length 内长 | Total Width 总宽 | Inner Width 内宽 | Total Height 总高 | Counter Height 台面高 | Depth 盆深 |
|--------------------|--------------------|-------------------|-------------------|--------------------|-----------------------|-------------|
| 490 | 460 | 430 | 295 | 160 | 111 | 105 |

Kohler reserves the right to change marked dimensions without prior notice.
科勒公司保留随时变更图中标示尺寸的权利，无需另行通知。

尺寸图

INSTALL NEW LAVATORY

- Cut the template on the cutout line.
- Position the template on the countertop to ensure clearance between the lavatory, faucet, and backsplash. Please fold the front end according to the marked folding line. Verify cabinet clearance beneath the countertop.
- Trace the template on the countertop with a pencil. Please do not surpass the folding line. Mark the two position of mounting holes on the countertop, measured by ROUGH-IN drawing.
- Re-check the clearance between the lavatory, faucet, backsplash, and cabinet. Adjust the template accordingly.
- Drill two $\phi 10$ holes at the position marked on the countertop.
- Cut the opening in the countertop along the inside edge of the pencil line.
- Please cut the cabinet according to the lines on the template. If the cabinet top is not flush with the countertop, please adjust the cutting lines of the cabinet top accordingly.
- Temporarily position the lavatory on the countertop, make sure the bolts are fixed through the mounting holes, and adjust to proper position.

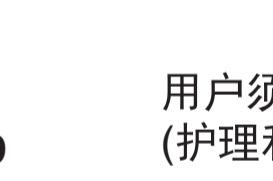
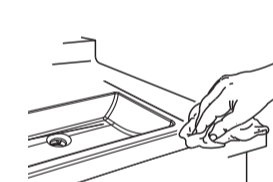
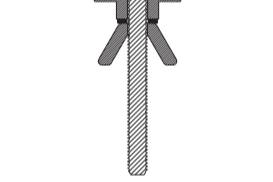
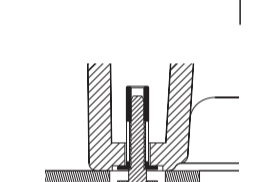
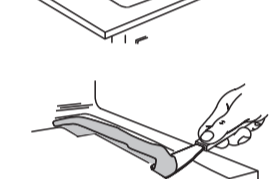
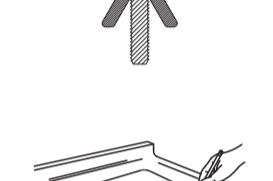
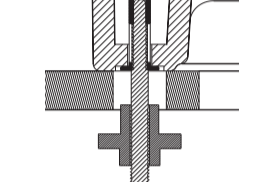
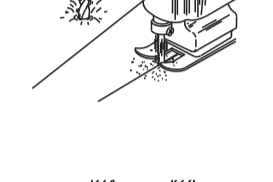
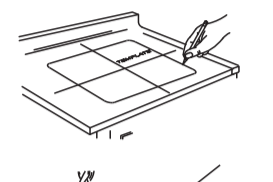

安装新脸盆

- 将切割图沿切割线切出。
- 将切割图放在盥洗台上，确保脸盆、水龙头和防溅挡板之间有足够距离。按照标明的线折叠前端。
- 查核盥洗台下的储物柜也有足够空间。
- 用铅笔沿切割图在盥洗台面划线，请勿越过折叠线。根据ROUGH-IN尺寸图在台面上标示出两个安装孔位。
- 再次检查脸盆、水龙头、防水板及储物柜的空间及距离。如有需要可调整切割图的位置。
- 用钻头在台面上的标示位钻2个 $\phi 10$ 的孔。
- 沿着自切割图勾划出来的铅笔线内侧切开台面。
- 按照样板线切割柜子，若柜面与台面不水平，请相应调整柜面切割线。
- 暂将脸盆放在台面上，确保螺栓穿过安装孔，校正位置。

CAUTION: Risk of personal injury or product damage. Large lavatories are very heavy. Get help lifting the lavatory into place.

CAUTION: Risk of personal injury or product damage. Large lavatories are very heavy. Get help lifting the lavatory into place.

- Immediately wipe away any excess sealant, and fill any voids as needed.
- Verify that the lavatory has not moved out of position.
- Allow the sealant to cure for at least 30 minutes before proceeding.
- Connect the faucet supply lines.
- Connect the drain assembly.
- Open the faucet valves, and check for leakage.
- Clean up with a non-abrasive cleaner.

小心：提防身体受伤或损坏产品。因大型脸盆相当重，需找人帮忙一起搬动及安放。

小心：提防身体受伤或损坏产品。因大型脸盆相当重，需找人帮忙一起搬动及安放。

- 立即擦去多余的密封胶，如脸盆外缘与台面间有缝隙，即用胶填满。
- 检查脸盆的位置准确。
- 最少待三十分种，让密封胶干透后，方可继续进行安装。
- 连接水龙头供水管。
- 连接排水装置。
- 开启水龙头阀门，检查有否渗漏。
- 用非腐蚀性清洁剂来清洁。

IMPORTANT CONSUMER INFORMATION (CARE AND CLEANING)

- To keep your lavatory looking new, make sure you rinse it out thoroughly after each use. **DO NOT USE ABRASIVES** on this product, as they will scratch and ruin the surface. Stubborn stains, paint, or tar can be removed with turpentine or paint thinner.
- Do not use the product in the water below 0°C.
- Please do not use hard materials (like scouring pad) to clean product surface, especially the product logo.

用户须知 (护理和清洁)

- 为保持脸盆光洁如新，须确保每次使用后彻底冲洗干净。切勿使用磨蚀性的清洁剂，以免刮花及破坏脸盆的表面。要清除顽固污垢、油漆或柏油，可使用松油或油漆稀释剂。
- 不要在0°C以下的水环境中使用。
- 请勿使用钢丝球等硬质材料擦洗产品表面，特别是产品商标处。

No.2 KOHLER ROAD, SANSHUI CENTRAL INDUSTRIAL PARK, LEPING TOWN, SANSHUI DIST., FOSHAN, GUANGDONG, PRC POST CODE: 528137
广东省佛山市三水区乐平镇三水中心工业园区科勒大道2号 邮编: 528137

8# MENGSHAN RD, ECONOMIC DEVELOPMENT ZONE OF HUANTAI, ZIBO, SHANDONG, CHINA POST CODE: 256410
山东省淄博市桓台经济开发区蒙山路8号 邮编: 256410

NO.1 KOHLER STREET, ECONOMIC DEVELOPMENT ZONE OF FAKU COUNTY, SHENYANG LIAONING PROVINCE, PRC POST CODE: 110400
辽宁省沈阳市法库经济开发区科勒大街1号 邮编: 110400

1326264-T01-B
© Copyright Kohler China Investment Co., Ltd. 2019
© 版权为科勒(中国)投资有限公司所有 2019