

ROUGHING-IN 产品尺寸图 (Unit:mm) (单位: 毫米)

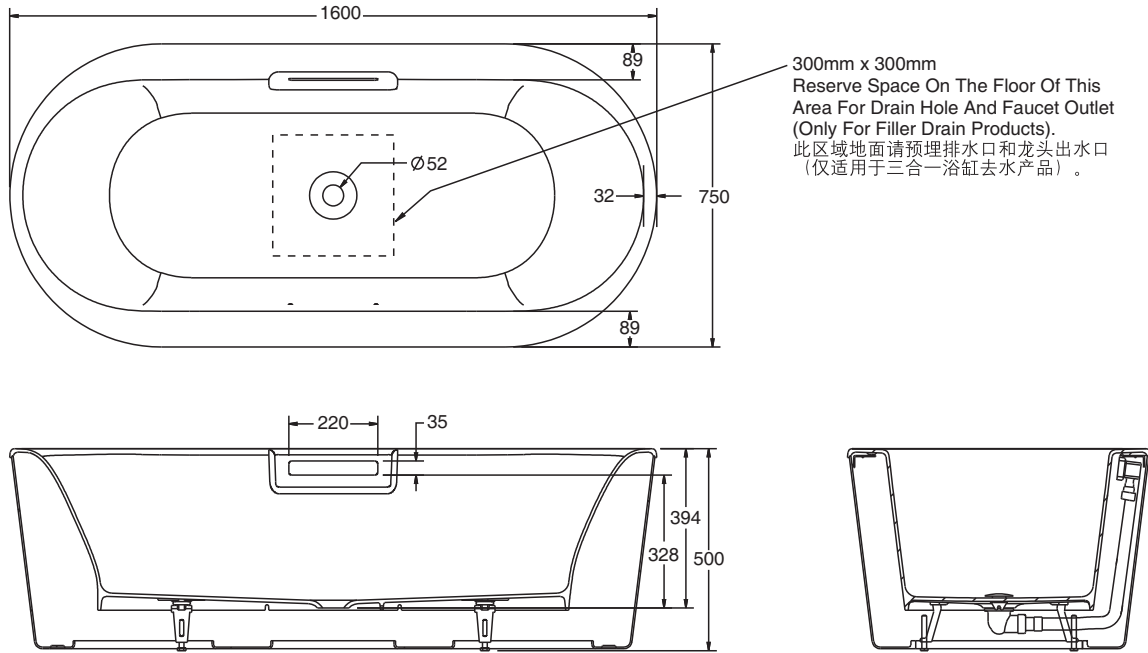

PRODUCT INFORMATION 产品信息

Water Depth 深度 (To Overflow Hole Bottom 至溢水口底部)	310mm(毫米)
Capacity 水容量 (To Overflow Hole Bottom 至溢水口底部)	170L(升)
Basin Area 底部面积	1100mm(毫米) × 405mm(毫米)
Top Area 顶部面积	1535mm(毫米) × 575mm(毫米)

Accessory Information 配件信息

Drain 排水K-99314T/K-18669T
 Adjustable Feet 可调节支撑脚K-18416T-NA

Optional Accessory Information 可选配件信息

Grip Rail 扶手K-5791T
 (For K-99313T-GR/FDGR)
 (适用于K-99313T-GR/FDGR)

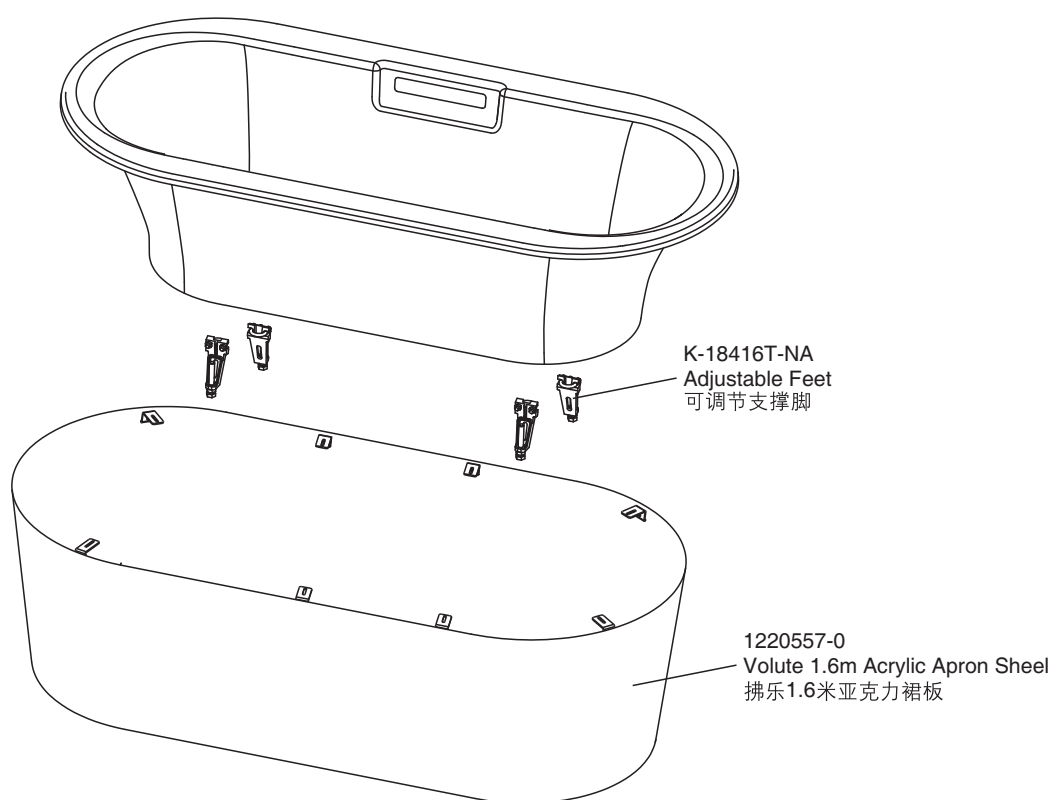

Drain service parts please refer to K-99314T/K-18669T.

排水的零件请参见K-99314T/K-18669T