

ROUGHING-IN 产品尺寸图 (Unit:mm) (单位: 毫米)

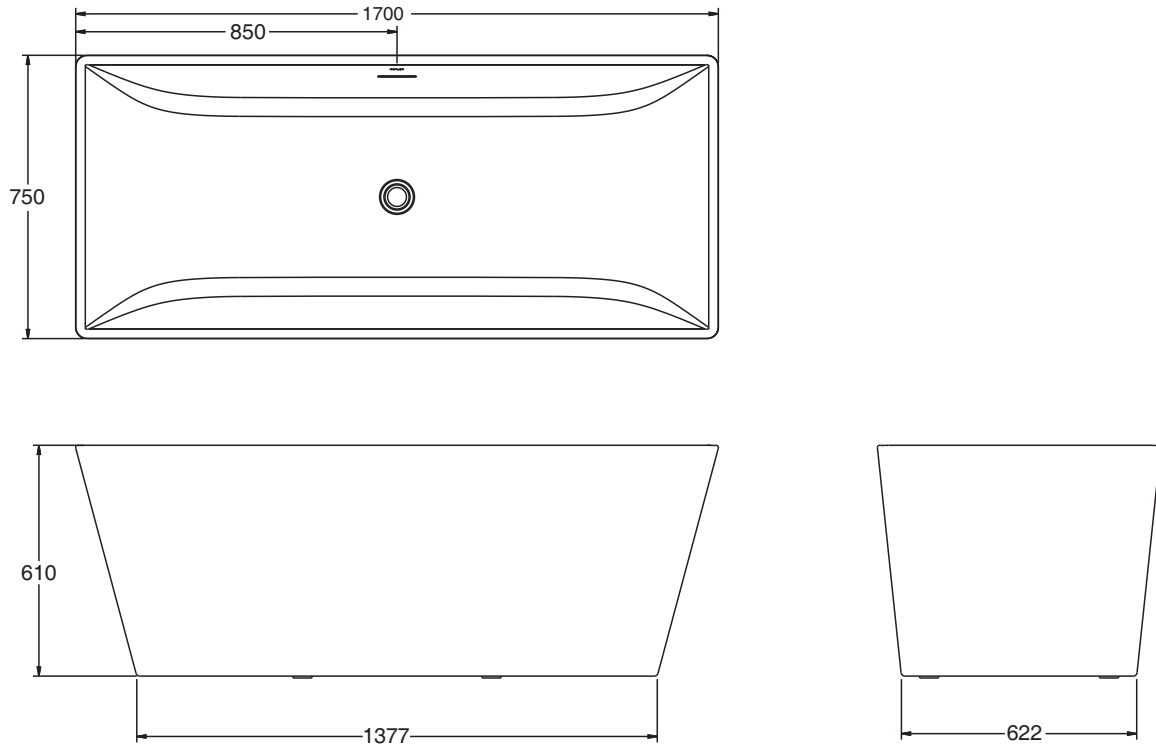

PRODUCT INFORMATION 产品信息

Water Depth 深度 (To Overflow Hole Bottom 至溢水口底部)	410mm (毫米)
Capacity 水容量 (To Overflow Hole Bottom 至溢水口底部)	282L (升)
Basin area 底部面积	835mm (毫米) × 424mm (毫米)
Top area 顶部面积	1648mm (毫米) × 699mm (毫米)

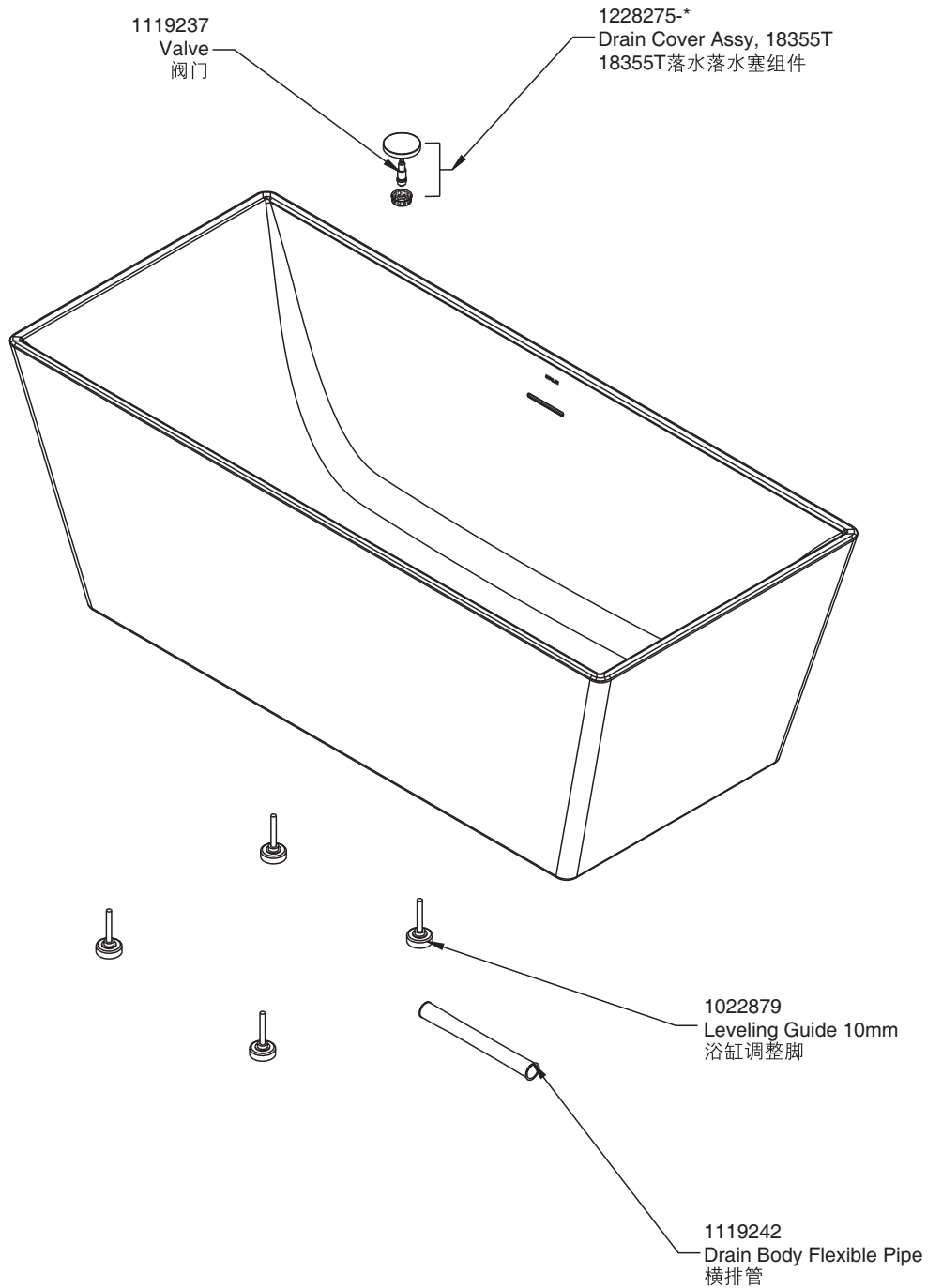

* Color code must be specified when ordering.
* 订货时必须指明表面处理/颜色代码