



INSTALLATION INSTRUCTIONS

安装说明书

ACRYLIC APRON BATH

伊普莱亚克力裙边浴缸

<h3>1. 安装之前</h3>	<h3>1. BEFORE YOU BEGIN</h3>
<h4>A. 引言</h4> <p>请仔细阅读此说明书以熟悉所需要的工具, 材料及安装顺序. 遵循适合您的特定安装要求的各项内容, 避免昂贵的损失. 除了要正确安装外, 还应阅读操作及安全说明.</p> <p>所有的资料是按最新出版的产品资料编写而成. 科勒中国有限公司保留任何时候无须通知即可改变产品特性, 包装或产品可供类型的权利.</p> <p>说明书包括重要的安装, 清洁及保养方面的内容, <u>请把这些资料交给用户阅读.</u></p> <p>注意: 请遵守当地的管道施工规范.</p>	<h4>A. Introduction</h4> <p>Please read these instructions carefully to familiarize yourself with the required tools, materials, and installation sequences. Follow the sections that pertain to your particular installation. This will help you avoid costly mistakes. In addition to proper installation, read all operating and safety instructions.</p> <p>All information is based on the latest product information available at the time of publication. Kohler China Ltd. reserves the right to make changes in product characteristics, packaging, or availability at any time without notice.</p> <p>These instructions contain important care, cleaning, and warranty information - please leave these instructions for the consumer.</p> <p>NOTICE: Observe all local plumbing codes.</p>
<h4>B. 产品信息</h4> <p>伊普莱(左出水口).....8772T 伊普莱(右出水口).....8770T 排水配件(推荐使用).....7160-AF</p>	<h4>B. Product Information</h4> <p>IMPRINT(left outlet).....8772T IMPRINT(right outlet).....8770T DRAIN(recommended).....7160-AF</p>

上海科勒有限公司
 上海市浦东星火开发区民乐路 368 号 邮编:201419

©版权为科勒中国有限公司所有, 2000
 Copyright © Kohler China Ltd., 2000

C. 产品要求

- 带裙边浴缸不能调换方向. 如果排水管和龙头在安装区域的左侧, 则需要安装左出水口的浴缸.
- 浴缸要安装在水平的未装修的地板上.
- 提供适当尺寸的安装空间.
- 小心地拆开包装以检查新浴缸. 确认浴缸没有损伤. 如果发现问题, 先不要安装, 立即把情况告知您的销售者.
- 请测量浴缸及要安装位置的尺寸, 以确保正好配套.
- 确保排水配件的位置正好对准浴缸的出水口.

C. Product Requirements

- Apron baths are not reversible. If the drain and faucet are on the left end of the recess area, the installation requires a left-outlet bath.
- Install the bath tub to a level subfloor.
- Provide properly-dimensioned space.
- Carefully uncrate and inspect the new bath for damage. Make sure there is no damage to the bath. If there is a problem, do not install the bath. Report the specific problem to your dealer immediately.
- Measure the bath and the area where the bath is to be installed to ensure a correct fit.
- Ensure that the drain location corresponds to the bath outlet.

2. 安装尺寸

测定安装尺寸

测量浴缸的长, 宽和深度. 参照第二页的尺寸, 核对所得的测量值.

在地板的排水孔处留出误差余量.

2. ROUGHING-IN

Determine Rough-in

Measure the height, width, and depth of the bath. Verify these dimensions with those on page 2.

Allow clearance at the drain hole location in the flooring.

8772T 左出水口, 如图示

8770T 为右出水口

单位: mm
UNIT: mm

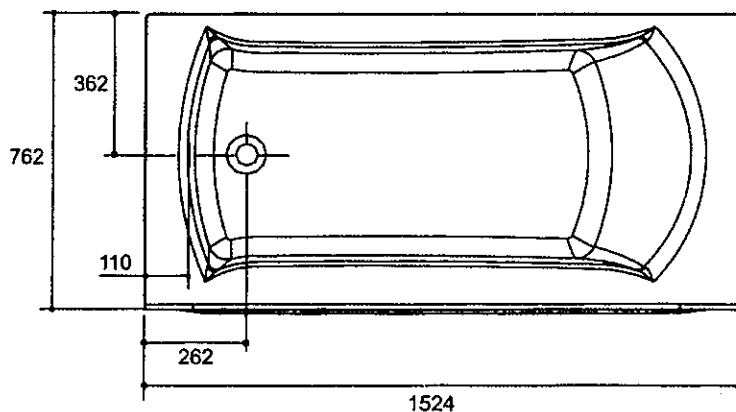

伊普莱
IMPRINT
重量: 38 Kg
WEIGHT: 38 Kg

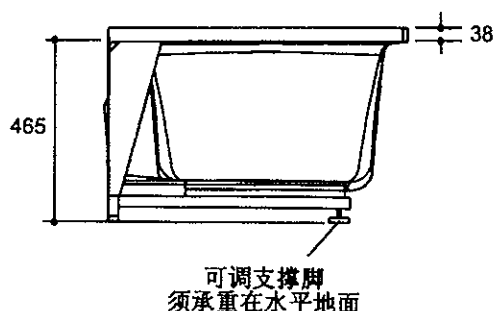

3. 安装要求

3. INSTALLATION REQUIREMENTS

A. 所需工具

- 管道扳手
- 刻度尺, 卷尺
- 水平仪
- 安全鞋
- 安全眼镜
- 直角尺
- 钳子

B. 所需材料

- 管道用油灰
- 墙面保护罩(如需要)
- 密封硅胶
- 浴缸保护套(如纸板)

A. Tools Required

- Adjustable pipe wrench
- Rule
- Level
- Safety shoes
- Safety glasses
- Square
- Pliers

B. Materials Required

- Plumbers putty
- Wall coverings, as necessary
- Silicone sealant
- Protective covering for bathtub or card board

C. 预留尺寸

检查安装尺寸及浴室尺寸, 确保有足够的空间安装浴缸.

C. Clearance Requirements

Check the rough-in and room dimensions to provide adequate available space for the bath unit.

4. 安装现场要求

4. SITE REQUIREMENTS

A. 拆除旧浴缸(如适用)

在存水弯处拆下排水管. 清除所有旧墙材料. 在旧浴缸下面塞入护板以保护地面, 并按如图所示把旧浴缸从安装空间拉出.

A. Old Bath Removal (If Applicable)

Disconnect the drain at the trap. Remove the old wall material. **Slip boards under the old bath feet to protect the floor,** and slide the old bath out of the recess as illustrated.

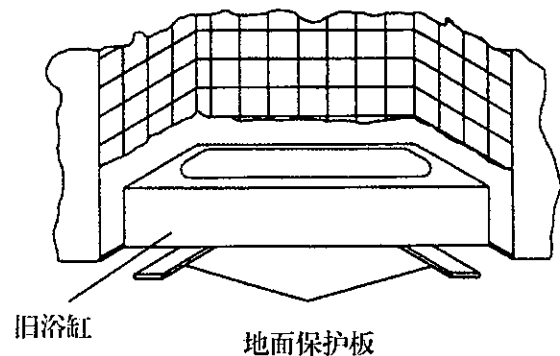

B. 未装修地板的准备

检查浴缸下的地板, 按需要进行修补. 确保未装修地板水平.

B. Subfloor Preparation

Check the flooring under the bath, and make repairs as needed. Make sure the subfloor is level and water proof.

C. 浴缸周围结构的准备

下图所示为几种常用的结构, 请确保浴缸凸缘嵌入瓷砖内, 不要暴露在外. 结构的长度应将底墙及装饰墙的厚度考虑在内.

对不同的支架结构方式, 也许有必要进行适度的调整.

C. Bath Area Construction Preparation

Possible construction arrangements are illustrated below. Make sure the tub flange will not be exposed, and it must be covered by the finished wall materials as shown. The construction should allow the thickness of the sub and finish wall materials. Some modifications may be needed for other types of construction, if preferred.

1). 三面靠墙安装:

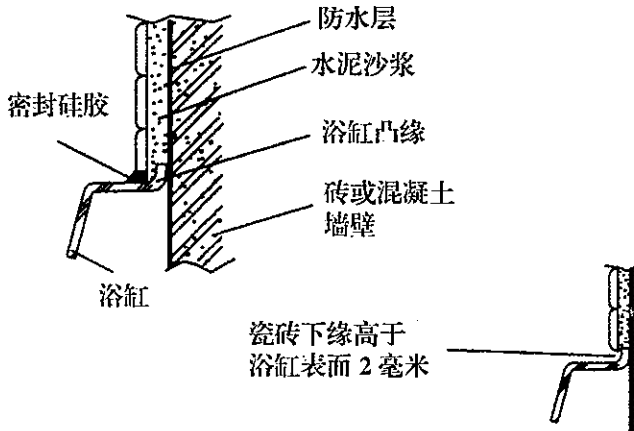

1). Recess Installation:

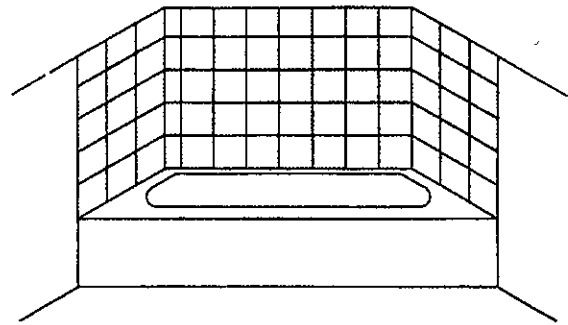

2). 墙角安装:

装饰矮墙详图

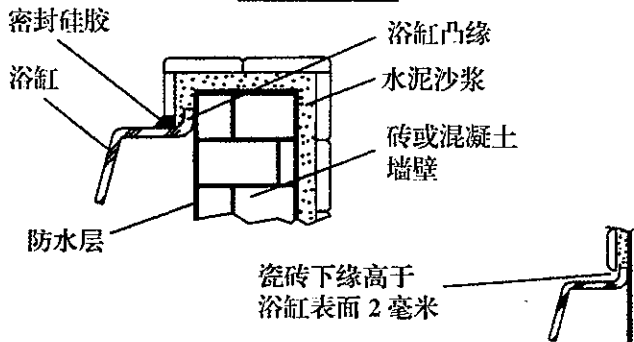

2). Corner Installation:

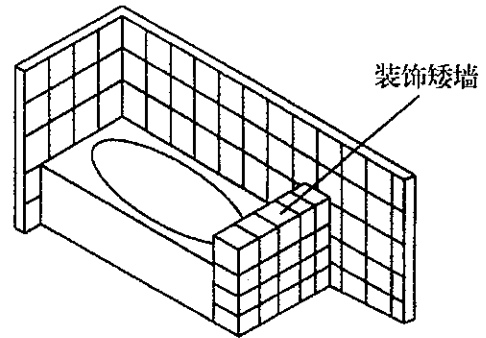

3). 超长三面靠墙安装:

装饰矮墙详图

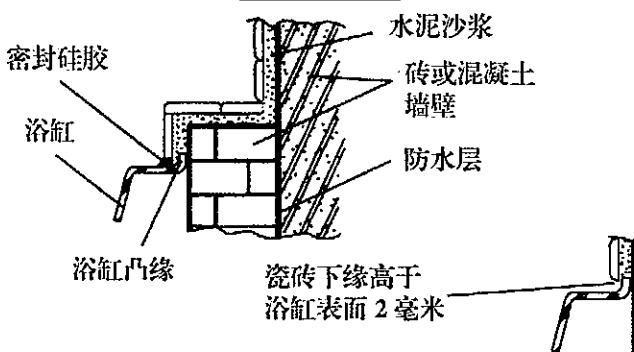

3). Over-sized recess installation:

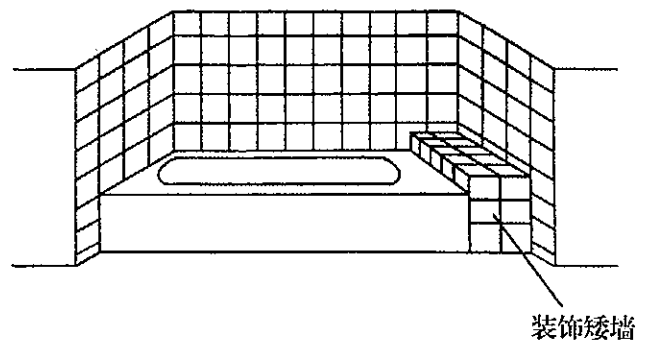

D. 定出排水管的位置

除非特别说明排水管是在地面以上安装外,应在地面合适的位置为排水管开出一个 152x305mm 的长方孔。

D. Determine Drain Rough-in

Unless the bottom of the bath is elevated for an above-the-floor drain installation, cut a minimum 152x305 mm hole in the floor for the drain connection.

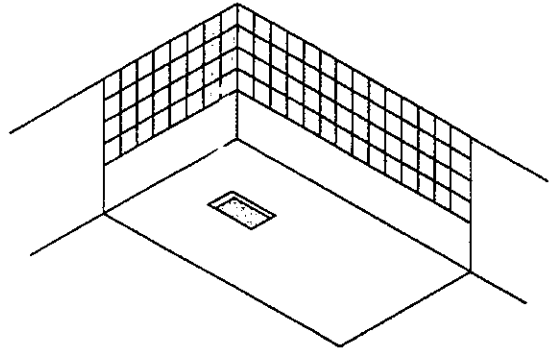

5. 安装浴缸之前

5. BEFORE INSTALL THE BATH

A. 局部安装浴缸的排水配件

按照厂家说明书,把排水配件部分安装在浴缸上。

A. Partially Install Bath Drain

Install the drain on the bath according to the drain manufactures instructions.

B. 保护浴缸

注意!

在浴缸表面盖上保护套或类似的材料,小心不要划伤浴缸表面。

- 不要把尖锐的杂物或器具放在浴缸内。
- 装饰墙壁时不要站在浴缸内或边缘上。
- 不要在浴缸内搅拌水泥。

B. Protect the Bath Unit

Position a protective covering or similar material in the bottom of the unit. Be careful not to scratch the bath surface.

- Do not put any sharp objects or equipment inside the bath.
- Do not stand on the bottom or the rim of the bath when finishing the walls.
- Do not mix the mortar inside the tub.

6. 安装浴缸

6. INSTALL THE BATH

A. 放置浴缸

将新浴缸放置在安装位置。

把排水管尾端插入存水弯。

如果有必要,将垫块垫在浴缸支撑脚下以调节浴缸水平。用水平仪沿浴缸的长短边缘测试,确保浴缸水平放置,并且所有的重量都均匀地承载在支撑脚上。如果靠墙的支撑脚难以垫到,则需要将浴缸搬出或搬进几次,直到垫好为止。

A. Bath Set-In

Slide the new bath into position.

Insert the drain tailpiece into the trap.

Level the bath by positioning shims under the bath feet, as needed. Check for level along the top of the side of the bath and across the drain end. The bath may have to be moved in and out of the recess area until it is shimmed properly, if the support feet are not accessible from the back or side.

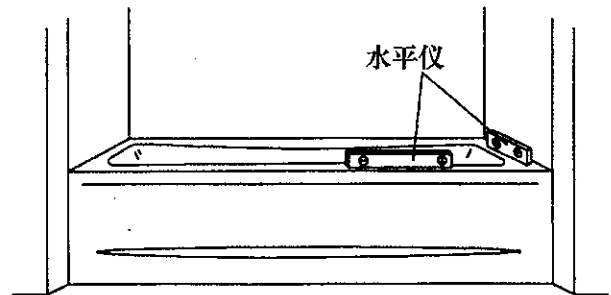

B. 安装卫生管道

注意!! 避免损坏浴缸底部和装修前的地面。浴缸的所有排水接口都要确保做防渗密封。

- 1). 当浴缸固定到位后, 将排水管与存水弯相接。如图 A。
- 2). 如果要进行地板上式排水安装, 浴缸应被垫高。排水三通应被旋转 90 度, 以配合地板上式排水管道系统。如图 B。
- 3). 安装水龙头阀门及喷头三通。打开冷水及热水阀门, 检查所有给水管接头是否有渗漏。
- 4). 让水流入浴缸, 检查排水配件接头是否有渗漏。

- 1). When the bath is securely positioned, connect the drain to the trap.
- 2). If installing the drain above the floor, the bath has to be raised up, and the drain tee should be rotated 90 degrees to facilitate the above floor drain plumbing. See fig.B.
- 3). Install the faucet valving and spout tee. Open the hot and cold water valves, and check the supply connections for leaks.
- 4). Run water into the bath, and check the drain connections for leaks.

B. Install Plumbing

CAUTION: Risk of damage to bath bottom and subfloor. Ensure a watertight seal on the bath drain connections.



图 A



图 B

7. 完成墙壁装饰

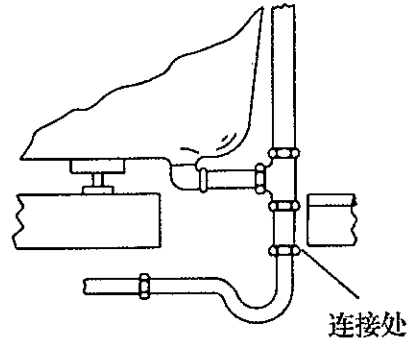
注意!! 当心人员受伤及浴缸损坏!

保护好浴缸表面后, 再安装墙壁贴面(如磁砖或大理石)。用硅胶密封浴缸边缘和贴面的连接处。建议使用常温下硬化的密封胶。

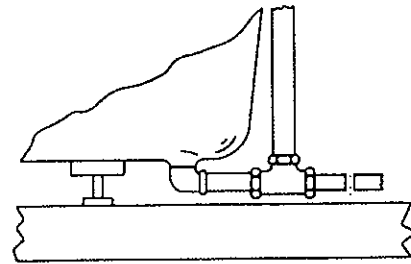
CAUTION: Risk of personal injury and product damage.

Install the finish wall material (ceramic or marble tiles). Use silicone sealant to seal the joints between the bath rim and the finished tiled wall. RTV(Room Temperature Vulcanizing) sealant is recommended.

7. COMPLETE FINISH WALL

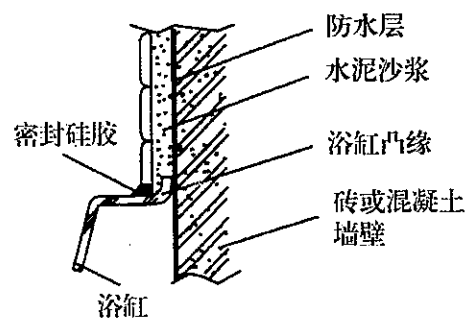

瓷砖下缘高于
浴缸表面 2 毫米

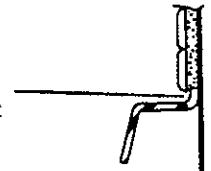

在浴缸裙板和地板贴面间涂一圈硅胶以防渗漏。

Apply a bead of silicone sealant over the seam between the bath apron and the finish floor.

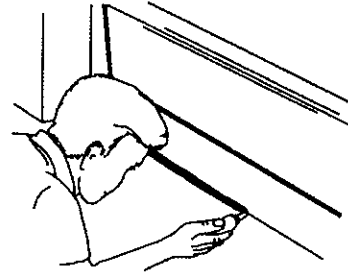

8. 完工清理

8. CLEAN-UP AFTER INSTALLATION

在安装完成后进行清理时，请勿使用磨损性的清洁用具，以免擦伤浴缸表面，使其失去光泽。使用温水和非磨损性的液体清洁剂，清洗浴缸表面。

When cleaning up after installation, do not use abrasive cleansers as they may scratch and dull the surface. Use warm water and liquid, non-abrasive detergent to clean the surface.

难以清除的污迹，油漆，或柏油，可用松节油或油漆稀释剂擦净。请不要让含有汽油溶解物的清洁剂和浴缸长时间接触。滞留水泥可用薄木刀刮掉。请不要使用金属刮刀，钢丝刷，或其它金属工具。对残留的灰泥，可用湿布粘些洗衣粉，以提供轻微的研磨作用。

Stubborn stains, paint, or tar can be removed with turpentine or paint thinner. Do not allow cleaners containing petroleum distillates to remain in contact with the bath surface for long periods of time. Plaster can be removed by scraping with wood edge. Do not use metal scrapers, wire brushes, or other metal tools. One of the powder type detergents may be used on a damp cloth to provide mild abrasive action to the residual plaster.

9. 重要的用户资料

9. IMPORTANT CONSUMER INFORMATION

A. 用户的责任

A. Consumer Responsibilities

清洗亚克力表面：请勿在亚克力表面使用磨损性的清洁用具，以免擦伤浴缸表面，使其失去光泽。每次使用后，将浴缸擦干，以防止肥皂和污垢沉积。

Cleaning Acrylic Surfaces: Do not use abrasive cleansers on any acrylic surfaces, as they will scratch and dull the surface. Wipe out the bath after each use to prevent a build-up of soap and scum.

若亚克力表面失去光泽，先使用汽车抛光剂，然后再用粗腊打亮。

If the acrylic surface becomes dull, an automotive type rubbing compound may be used on the unit, followed by an application of paste wax.

B. 售后服务

B. Requesting Service

请抽出一些时间来了解科勒的担保, 权益, 及限制。
当您需要服务帮助时, 请按下列步骤联系:

Please take a moment to familiarize yourself with the Kohler warranty, its benefits, and limitations. Here is what you need to do if you require service:

第一: 与产品的销售者, 或安装承建者联系. 他们应该能够解决您所遇到的问题.

FIRST: Contact the dealer or contractor who sold and installed the product. They should be able to solve any problems you may have.

第二: 如果您的产品销售者, 或安装承建者解决不了问题, 他们将与科勒的经销商联系, 或提供他们的名字.

SECOND: If your dealer or contractor cannot solve the problem, they will contact or supply you with the name of the local Kohler Distributor.

第三: 如果您无法得到安装承建者或科勒中国有限公司的经销商的担保服务, 请直接写信给:

THIRD: If you are unable to obtain the warranty service through either your contractor or Kohler China Ltd. distributor, please write us directly:

上海市卢湾区淮海中路 138 号
上海广场 19 楼
邮编: 200021
科勒中国有限公司
中央客户服务中心

Central Customer Service Center
Kohler China Ltd.
19/F, Shanghai Square,
138 HuaiHai Road, Luwan District
Shanghai, PRC, Post Code: 200021

第四: 请将与您申报有关的资料全部寄来, 包括完整的产品名称, 型号, 颜色, 表面处理和产品的安装日期. 同时附带描述问题产生的情形, 以及所涉及产品的购货发票复印件. 另外, 再提供您的安装承建者或经销商的名字.

FOURTH: Include all pertinent information regarding your claim, including a complete description of the product, model numbers, colors, finishes, and the date the product was installed. Include a description of the problem, and a photocopy of your invoice for the products involved. Also give us the name of the contractor and distributor.

上海科勒有限公司
上海市浦东星火开发区民乐路 368 号 邮编:201419