

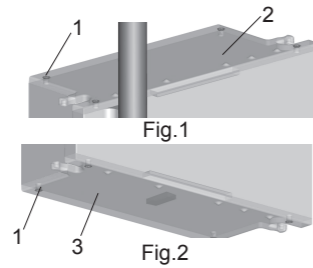

## 安装步骤

### 拆卸上、下盖

用螺丝刀旋下螺钉(1),取下上盖(2)和下盖(3)。



## INSTALLATION

### Disassemble Upper and Lower Covers

Unscrew the screws(1) with screwdriver. Take off the upper cover(2) and the lower cover(3).

### 如何安装托盘

安装淋浴屏之前,先安装托盘(5)。再将托盘T型凸起对准壳体上的T型槽装入。用螺钉(4)锁紧。

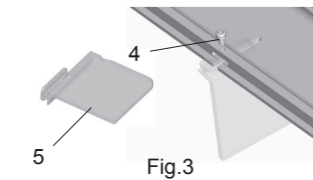

### How to Install the Shelves

Before installing the shower panel, Install the shelves(5) first. Install the shelves with the T-tab of its being situated into the T-slot of the extrusion. Secure it by screws(4).

### 如何安装淋浴屏

安装G3/4"供水管(6,用户自备),热供水管装在左侧。推荐的接管中心到装修好的浴室地面的高度1100mm。两接管中心距离150mm,保持水平,垂直于装修好的墙面。伸出墙面的长度20-40mm。

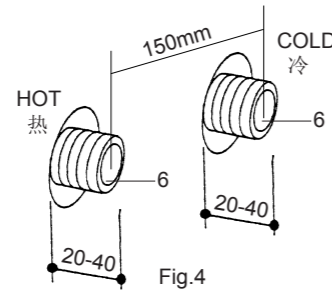

### How To Install The Shower Panel

Install G3/4" male supply fittings(6, not provided). Hot one must be located on the left. The recommended height from center of the fittings to the finished floor of the bathroom is 1100mm. The fittings are spaced 150mm apart from center to center, level, and vertical to the finished wall. And fittings extend beyond the finished wall 20-40mm.

先将安装模板冷热进水孔位置用刀划十字。

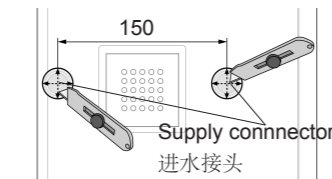

Cut crosses at the hot and cold water supply connectors on the mounting templet with knife.

将安装模板套在装好的接管上,找正模板。用胶条固定。在模板标识的位置上打三个直径8mm的孔。如图Fig.5所示。

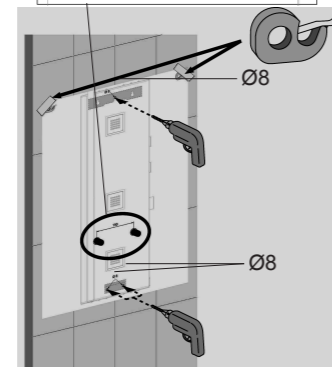

Put the mounting templet over the G3/4" male supply fittings. Position it. Stick it onto the finished wall with adhesive tape. Drill three holes(diameter 8mm) on the finished wall as the locations on the mounting templet, as Fig.5 shown.

取下安装模板,安装胀塞(8)、螺钉(10)、垫片(9)和蝶形螺母(7)。

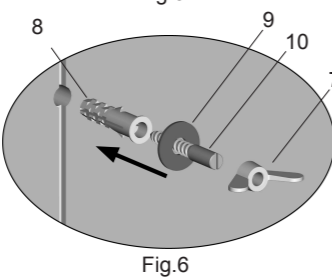

Take off the mounting templet. Install the anchor(8), screw(10), washer(9) and butterfly nut(7).

# KOHLER®

## SERVICE PARTS

### 零件图

# 水魔方

## WATERTILE TOWER

### 淋浴屏 Shower Panel

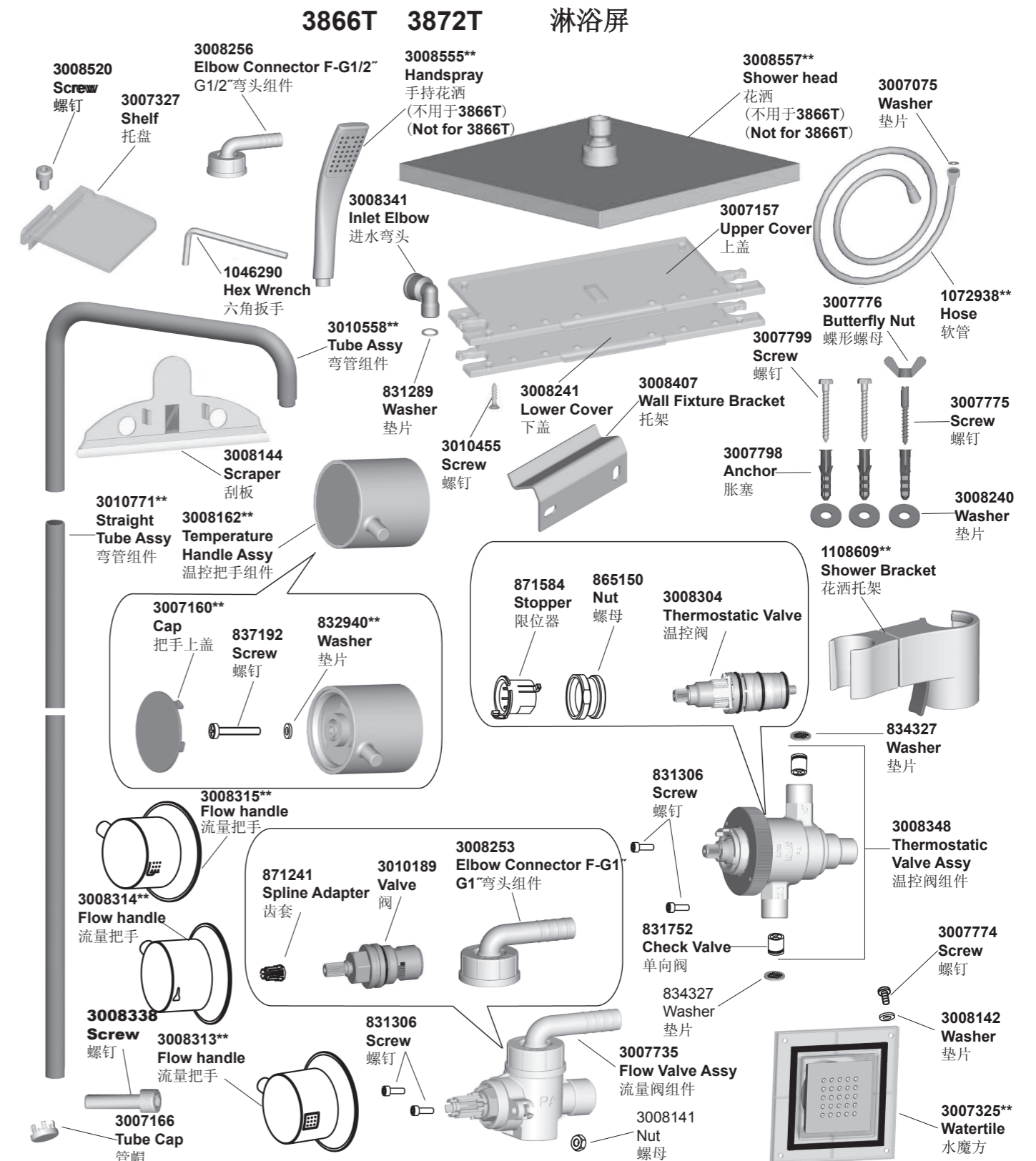

\*\*订购时请说明颜色编号

\*\*Color code must be specified when ordering

## 如何清除喷嘴水垢，杂质

喷嘴杂质或结垢会导致水流变形，流量变小。打开水魔方，用手指用力按压或摩擦橡胶喷嘴，去除杂质或水垢。

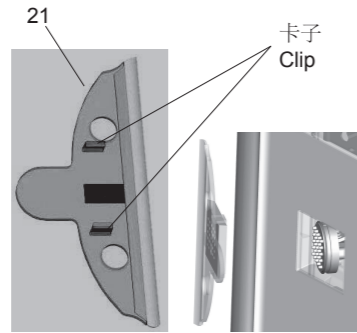

Fig.23

用同样的方法清理手持花洒和花洒头中的杂质。

如需进一步清理水魔方，需要用刮板(21)上的卡子卡住水魔方面板(39)，将其取下。打开水魔方，用力按压或摩擦橡胶喷嘴，去除水垢或杂质。

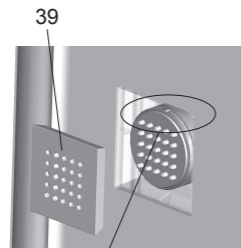

Fig.24

清理完毕后，将喷嘴主体上的凸起对准水魔方面板内的凹槽安装水魔方面板。

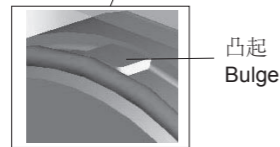

Fig.25

## How to Clean the Nozzles

Any debris or mineral build-up may cause the flow stream to become distorted or reduce the flowrate. To remove the debris or mineral build-up, run water through the watertile, press or rub the fingers back and forth across the rubber nozzles.

The handspray & shower head can be cleaned up by the same way.

If need to clean watertiles further. Grasp the faceplate(39) with the clips on the scraper(21) to take it off. Run water through the watertiles, firmly press or rub your finger back and forth across the rubber nozzles.

After cleaning, install the faceplate with the notch of faceplate being situated over the bulge on the supporter of nozzles.

## 清理说明

## CLEANING INSTRUCTION

适用于所有加工处理过的表面：以中性肥皂水清洗镀层表面，再以干净的软布彻底擦干整个表面，许多清洁剂，比如氨水、去污粉及洁厕灵等，会对电镀表面造成伤害，切忌使用。

All Finishes: Clean the finish with mild soap and warm water. Wipe entire surface completely dry with clean soft cloth. Many cleaners may contain chemicals, such as ammonia, chlorine, toilet cleaner etc. which could adversely affect the finish and are not recommended for cleaning.

有腐蚀性的清洁剂或溶剂不可使用于科勒牌的水龙头及其附件上。

Do not use abrasive cleaners or solvents on Kohler faucets and fittings.

用胀塞(8)、垫片(9)和螺钉(11)安装托架(12)。用水平尺找平托架(参照Fig.8)，用扳手锁紧螺钉以固定托架。

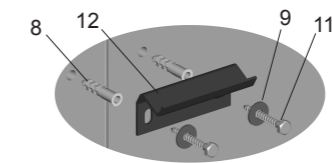

Fig.7

在两个G3/4"供水管(6)螺纹上缠绕足以密封的密封胶带或涂上适合的密封胶，然后将进水弯头(13)旋紧到供水管上，方向朝下。

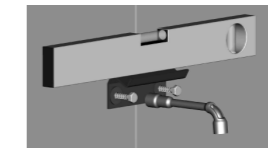

Fig.8

开启主水源，让水流出约一分钟，以清除杂质。

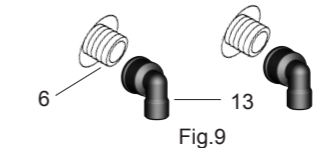

Fig.9

将淋浴屏下背板(16)支撑在托架(12)上(参照Fig.12)。将上背板(15)上的挂钩(14)挂到垫片(9)的下面(参照Fig.10)。

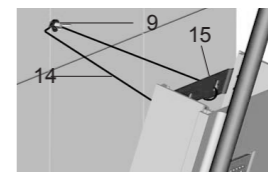

Fig.10

将软管(18)带垫片(17)连接到进水弯头(13)上。**注意：**与阀体上有HOT标志接头相连的软管接热水。

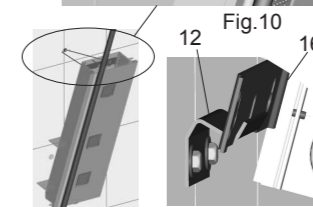

Fig.11

Fig.12

后推淋浴屏。脱开挂钩小心上举淋浴屏，使上背板上的开槽从垫片(9)后面卡入螺钉(8)，同时将下背板插入托架(参照Fig.14)。找正淋浴屏。锁紧蝶形螺母(7)固定淋浴屏。

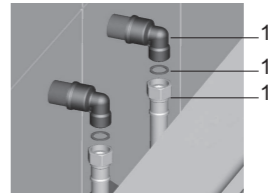

Fig.13

将花洒托架(19)按图示(参照Fig.14)安装到直管组件(20)上。

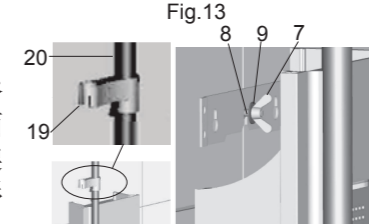

Fig.14

重新装回上盖和下盖。

**注意：**有磁块的为下盖，磁块用于吸附刮板(21)。

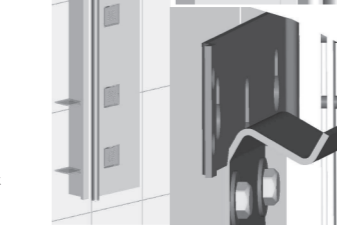

Fig.14

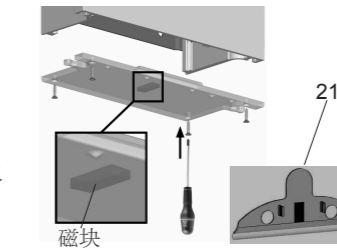

Fig.15

Mount the wall fixture bracket(12) by anchors(8), washers(9), screws(11). Make sure the bracket level and secure. Refer to Fig.8.

Apply tape or thread sealant to threads of G3/4" fittings(6). Install the inlet elbows(13) onto the fittings. Outlets of the elbows facing downwards.

Turn on the main water supply. Run water for about one minute to remove any debris.

Support the lower base (16) of the shower panel onto wall fixture bracket(12), referring to Fig.12. Hang the hook(14) which attached to upper base(15) under the washer(9), referring to Fig.10.

Connect the hoses(18) with washers (17) to inlet elbows(13). **Note:** The hose connecting to valve connector with HOT mark should attach to hot water supply.

Push back the shower panel. Unlock the hook. Carefully lift the shower panel. Riding the slot of the upper base onto the screw(8) from the back of the washer(9). At the same time, insert the lower base into the behind of the wall fixture bracket, referring to Fig.14. Position the shower panel. Tighten the butterfly nut(7) to secure the shower panel.

Install shower bracket(19) onto tube assy(20), referring to Fig.14.

Reinstall the upper cover and the lower cover.

**Note:** The lower cover is with magnet. The magnet is used to hold the scraper(21).

## 如何安装弯管

将弯管(22)对准淋浴屏上的直管组件(20)插入,用六角扳手(24)将螺钉(23)锁紧到弯管上。

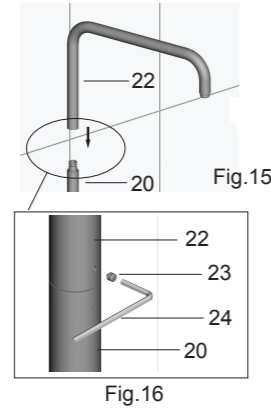

## How to Install the Tube assy

Insert the tube(22) into the tube assy(20), Tighten the screw(23) with hex wrench(24).

## 如何安装花洒头

据需要安装限流器(见限流器说明),将垫片(25)放入花洒(26,不用于3866T)接头内。将花洒头旋到弯管(22)上,用带状扳手锁紧。

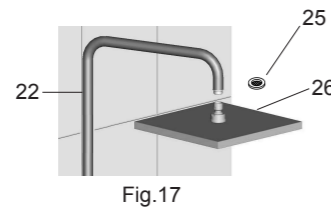

## How To Install The Shower Head

Install the regulator of shower head as required (shown in regulator installation instruction). Put the washer (25) into shower head (26, not for 3866T) connector. Thread the shower head onto the tube assy(22), tighten with strap wrench.

## 安装手持花洒

先将软管(29)连接到出水接头(28),再将软管另一端连接到手持花洒(27,不用于3866T)。锁紧所有衔接螺母。把花洒挂在花洒托架(19)上。

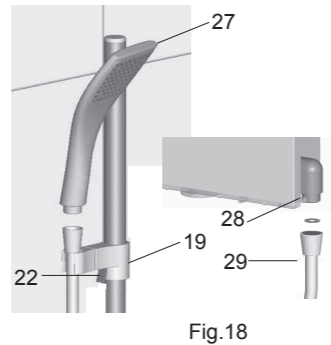

## Install The Handspray

Connect the hose(29) to elbow outlet(28). Connect the hose to handspray(27, not for 3866T). Tighten all the nuts. Hang the handspray on the shower bracket(19).

按住花洒托架的簧片上下滑动,可调节托架位置。

The height of bracket can be adjusted by pressing the pinch cock and sliding up and down.

将软管卡在托盘缺口和壳体之间。

Nip the hose in the gap between shelves and the extrusion.

## 使用说明

## HANDLE OPERATION

自上而下开始,第一个把手控制头部花洒出水,逆时针旋转把手为开。第二个把手控制水魔方出水,逆时针旋转把手为开。第三个把手控制手持花洒出水,逆时针旋转把手为开。最后一个把手控制温度,慢慢地旋转温控把手,调整温度,安全限位温度为38°C。如果想得到更高的温度,按住按钮继续旋转。

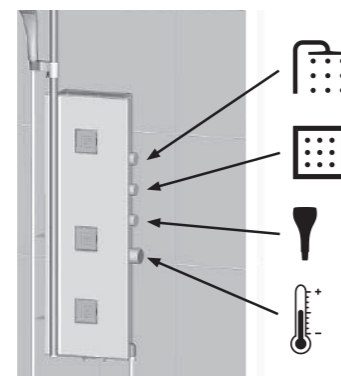

From top of the shower panel, the first handle controls shower head. The handle opens with one-quarter turn counter-clockwise. The second one controls watertiles. The operation is the same as the first one. The third one controls handspray. The operation is the same as the first one. The last one controls temperature, The temperature is set by slowly turning the temperature handle. For safety reasons, there is a stop that limits temperature to 38°C. To get a higher temperature, push the button and continue turning the temperature selector.

## 维护与保养

### 温控阀清洗

如果供水的水质较硬或长时间使用,水垢或杂质会阻塞温控阀上的滤网,使流量降低。需要清理请按照下列步骤进行:

关闭供水系统,使流量阀处于打开位置后进行温控阀的拆卸作业。温控阀是较敏感的配件,所以要十分小心。

拆卸上下盖,松开蝶形螺母,挂上挂钩,取出淋浴屏支撑在托架上。

拆卸前确保把手朝后方。卸下温控把手组件:取下把手上盖(34),用螺丝刀旋下螺钉(33),取下垫片(32)和温控把手组件(31)。然后用3毫米六角扳手将螺钉(30)卸下(图Fig.20)。从淋浴屏后面将温控阀组件(35)取出。旋下限位组件(36,图Fig.22)。小心地卸下温控阀(37)用热醋进行清洗。

清洗后,将限位组件装到温控阀上,使塑料套的定位柱嵌入温控阀的限位槽内(图Fig.22)。然后将塑料套的定位柱与本体(38)内孔凹槽对齐,装入温控阀并锁紧螺母(图Fig.23)。装回温控阀组件,用螺钉(30)锁紧。装回温控把手组件。按前述装回淋浴屏及上下盖。

## CARE AND MAINTENANCE

### Clean Thermostatic Cartridge

Very hard water can obstruct the filters on thermostatic cartridge and reduce the flow of water. Please clean the cartridge as follows:

Shut off the water supplies of the faucet and open the flow valve, then proceed to remove the cartridge. The cartridge is sense organ, please be careful.

Disassemble the upper and down covers. Loosen the butterfly nut. Hang the hook. Take out the shower panel and hold it on wall fixture bracket.

Make sure the handle faces backwards before your action. Remove the temperature handle kit: Remove the temperature handle cap(34), unscrew the screw(33) with screwdriver. Take off the washer(32) and the temperature handle kit(31). Unscrew the screws(30) with 3mm hex wrench (Fig.20). Take out the temperature valve kit(35). Remove stop assembly(36). Removing the thermostatic cartridge(37) cautiously(Fig.22). Clean the thermostatic cartridge by soaking it in warm vinegar.

After cleaning, install the "stop assembly" back to the cartridge, adjusting the stop pin into the notch(Fig.22). Install the cartridge and stop assembly into the body(38), adjusting the stop pin into the notch of the body(Fig.23). Reinstall the temperature valve kit. Secure it by screws(30). Reinstall the temperature handle kit. Reinstall the shower panel and the upper & down covers as previous procedure.

